



深圳市格天光电有限公司

Shenzhen Getian Opto-Electronics Co., Ltd

产品规格书

The product specification

CUSTOMER/客户名称: _____

MODEL NO./产品型号: _____ GT-P04Y2410140

DESCRIPTION/产品描述: _____ 1W黄光

SAMPLE DATE/送样日期: _____

CUSTOMER AUTHORIZED SIGNATURE/客户承认签核

Please return to us a copy of "APPROVAL SHEET" after customer Sign it./客户签字确认，盖章后请回传一份承认书至我司。

engineering department 工程部		
APPROVED (核准)	CHECKED (审核)	DRAW UP (制定)

ADD: Building 55, East of Baotian Third Road, Xixiang, Baoan District,
Shenzhen City, Guangdong Province, China 518102
地址: 深圳市宝安区西乡镇宝田三路东55栋

Tel/电话: 86-755-29656850
Fax/传真: 86-755-29656880
Http: //www.gt-led.com
E-mail: getian@led.com

GT-POWER LED Series

Technical Datasheet for GT-03/04

GT-Power series is designed for high current operation and high flux output applications. GT-Power LED its thermal management perform exceeds then other power LED solutions.

It integrate of the art SMD design and thermal emission material.

GT-Power LED is ideal light sources for general applications, custom designed solutions, and automotive large LCD backlights.

GETIAN SEMI CONDUCTOR

只做大功率



Features

- *Super high Flux output and high Luminance
- *Designed for high current operation
- *Low thermal resistance
- *SMT solder bility
- *Lead Free product
- *ROHS compliant

Applications

- *General Illumination
 - Outdoor & Indoor architectural lighting
 - Decorative lighting
 - Torch lighting
 - Portable lighting and Reading lighting
 - Traffic signaling

Full Code of GT-Power LED Series

Full code form:	<u>GT</u>	-	<u>P</u>	<u>XX</u>	<u>XX</u>	<u>X</u>	<u>X</u>	<u>X</u>	<u>X</u>	<u>XX</u>
	1		2	3	4	5	6	7	8	9
	GT		P	04	Y2	4	1	0	1	40

Part Number

1- GT: GeTian

2- P : High Power LED

3- XX: Part sort

03: With baseplate 04: Without baseplate

4- XX: Emitted Color

R1 - Red 625nm B3 - Blue 465nm Y2 - Yellow 590nm

5- X : Wafer Size

2 - 24mil 3 - 30mil 4 - 42mil 5-50mil 6 - 60mil

6- X : Wafer Quantity

1 - 1EA 4 - 4EA

7- X : Viewing Angle

0 - 120deg 1 - 15deg

8- X : Power

0 - 0.5W 1 - 1W 3 - 3W

9- XX: Brightness Grade

40 - 40-50lm 130 - 130-140lm

Outline Dimensions

1、 Dome Type

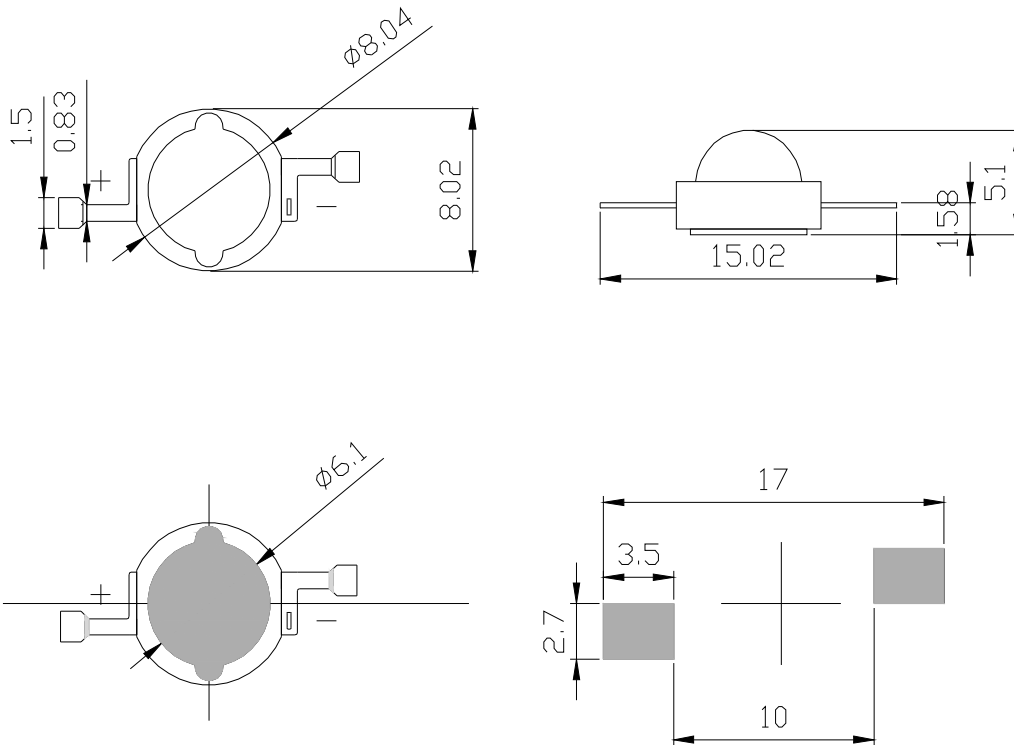

2、 Circuit diagram

[INTERNAL CIRCUIT DIAGRAM]

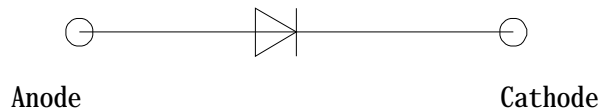

Notes

1. All dimensions are in millimeters.(tolerance:±0.2)
2. Scale:none

*the appearance and specifications of the product may be changed for improvment without notice.

Characteristics for GT-P04Y2410140

1、Neutral -White

1-1 Electrical-Optical Characteristics at IF=400mA, TA=25°C

Parameter	Symbol	Value			Unit
		Min	Typ	Max	
Luminous Flux ^[1]	ϕ_v ^[2]	40	~	50	lm
Wavelength ^[3]	~	588	~	593	nm
Forward Voltage ^[4]	V _F	2.0	~	2.6	V
View Angle	201/2	120			deg.
Thermal Resistance ^[5]	R θ_{J-B}	8			°C/W
Thermal Resistance ^[6]	R θ_{J-C}	6.5			°C/W

1-2 Absolute Maximum Ratings

Parameter	Symbol	Value	Unit
Forward Current	I _F	400	mA
Power Dissipation	P _D	1	W
Junction Temperature	T _j	120	°C
Operating Temperature	T _{opr}	-30~+85	°C
Storage Temperature	T _{stg}	-40~+120	°C
ESD Sensitivity ^[7]	~	±2,000V HBM	~

*Notes:

[1] SSC maintains a tolerance of ±10% on flux and power measurements.

[2] ϕ_v is the total luminous flux output as measured with an integrated sphere.

[3] Correlated Color Temperatures is derived from the CIE 1931 Chromaticity diagram.

CCT ±5% testing tolerance

[4] A tolerance of ±0.06V on forward voltage measurements

[5] ,[6] R θ_{J-B} is measured with a SSC metal core pcb.(25°C ≤ T_J ≤ 110°C)

R θ_{J-C} is measured with only emitter.. (25°C ≤ T_J ≤ 110°C)

Break voltage of Metal PCB is 6.5kVAC

[7]It is included the zener chip to protect the product from ESD.

-----**Caution**-----

Please do not drive at rated current more than 5sec. Without proper heat sink

White Binning Information

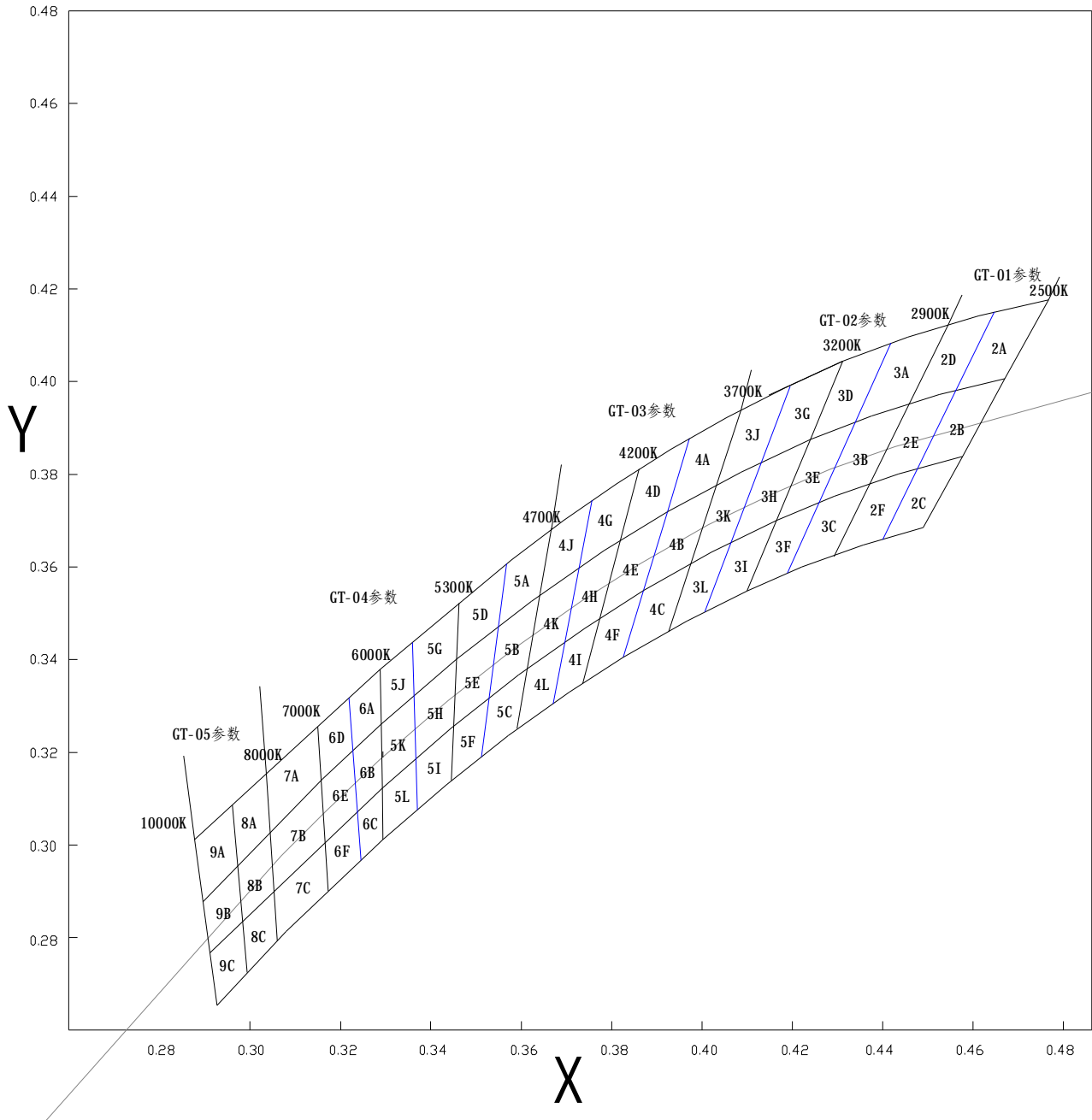

White Binning Sluze

Division of BIN code and sample BIN code for white light				
BIN code	Color Temperature Range		Center Value	Sample BIN Code
2A/2B/2C/2D/2E/2F	2500-2900K		2700K	2E
3A/3B/3C/3D/3E/3F	2900-3200K		3000K	3B
3G/3H/3I/3J/3K/3L	3200-3700K		3500K	3H
4A/4B/4C/4D/4E/4F	3700-4200K		4000K	4E
4G/4H/4I/4J/4K/4L	4200-4700K		4500K	4H
5A/5B/5C/5D/5E/5F	4700-5300K		5000K	5B
5G/5H/5I/5J/5K/5L	5300-6000K		5700K	5K
6A/6B/6C/6D/6E/6F	6000-7000K		6500K	6B
7A/7B/7C	7000-8000K		7500K	7B
8A/8B/8C/9A/9B/9C	8000-10000K		9000K	8B
1.The division of luminous flux for white light is 10LM per grade				
2.The division of voltage for white light is 0.2V Per grade				
BIN Division Standard Of Red,Green,Blue				
Wavelength	Color	Lumen	Voltage(0.2V/each)	Total Amount of BIN
615-630 (2.5nm/each)	Red	10LM/each	2.0-2.6	36
515-530 (2.5nm/each)	Green	10LM/each	3.0-3.6	36
455-470 (2.5nm/each)	Blue	10LM/each	3.0-3.6	36

1、Typical Radiatiation Patterns

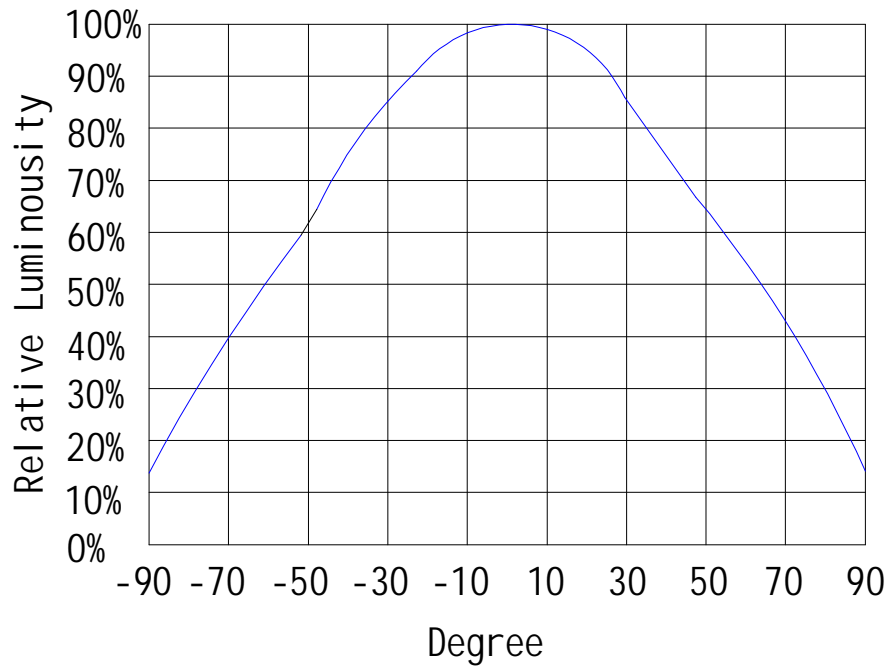

2、Typical representative Spatial Radiation Pattern

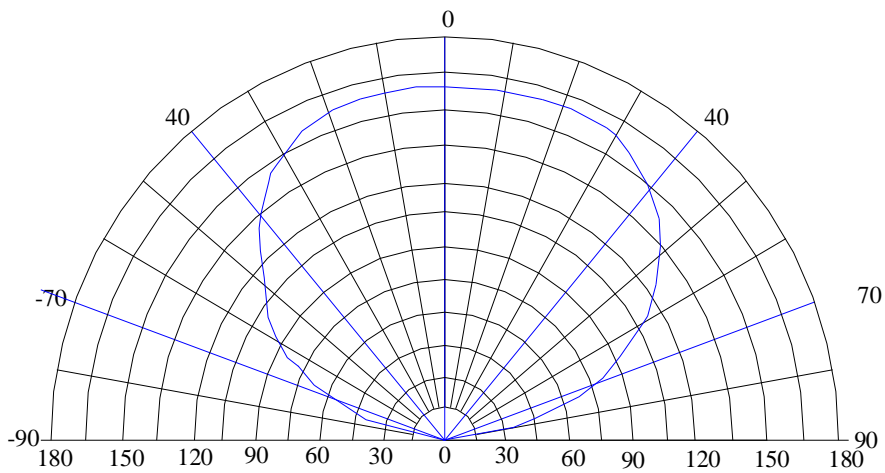

Typical Polar Radiation Pattern for White Lambertian

3、Neutral -White color spectrum of typical CCT part, integrated measurement

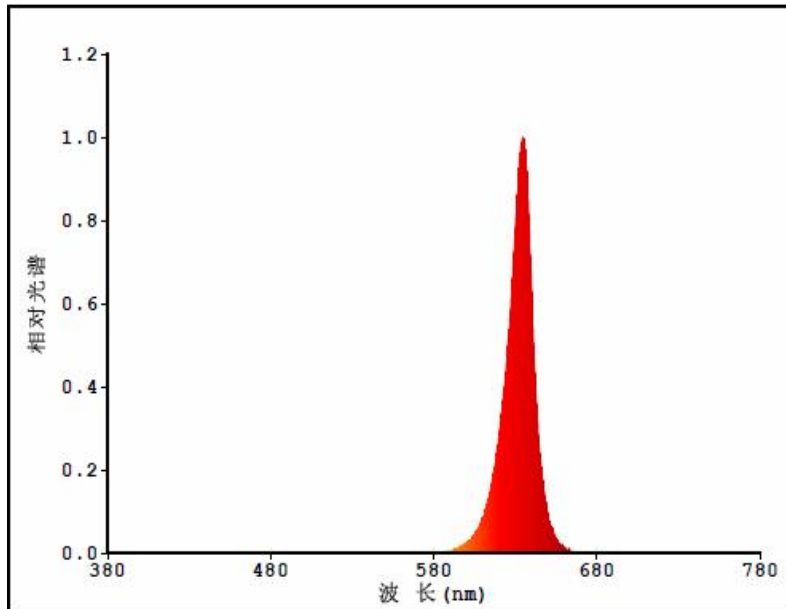

4、Forward Current vs.Forward Voltage

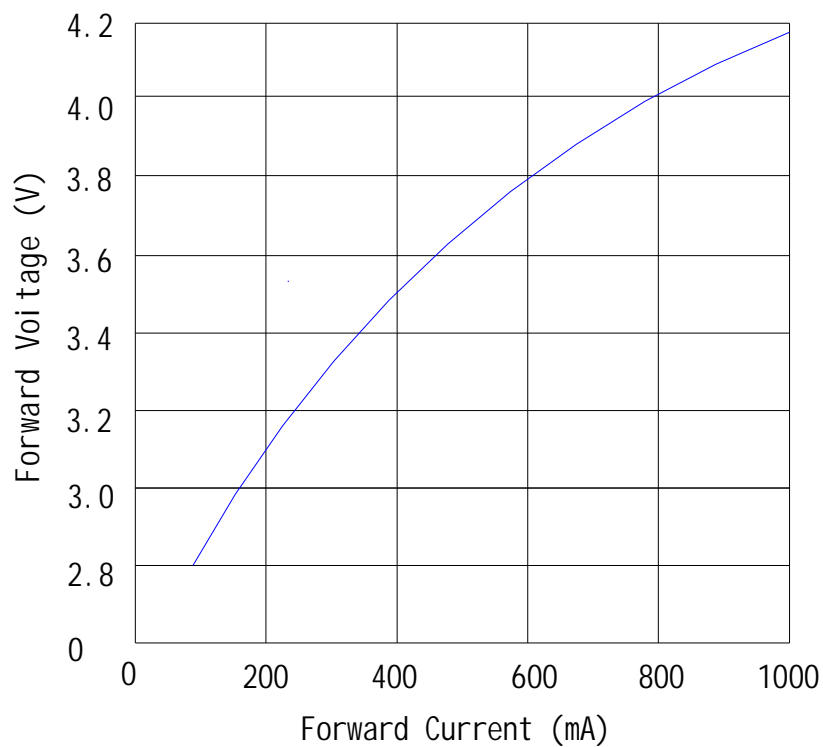

5、Relative Luminous Intensity vs. Ambient Temperature

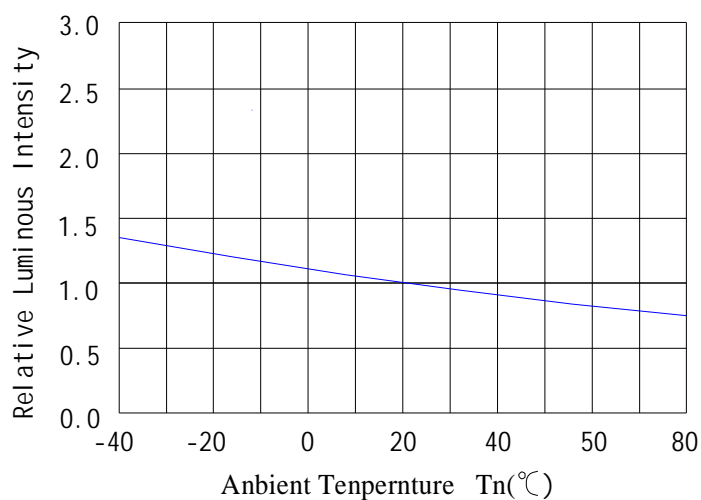

6、Forward Current Derting Curve, Derting based on T_{imax}=125°C

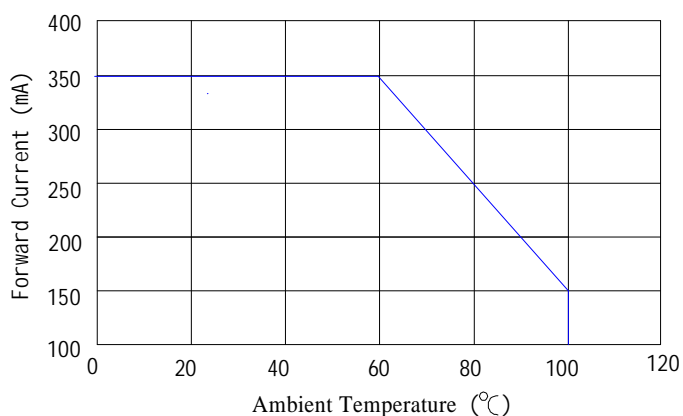

7、Relative Luminous Flux vs. Forward Current

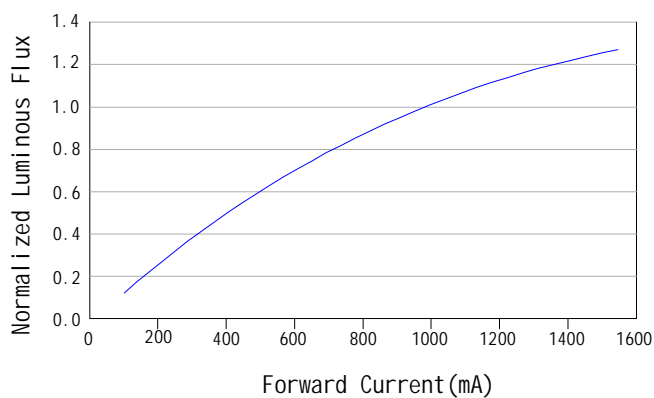

Test Items And Condition

Items	Test Condition	Test Hours Cycles	Sample Size	Ac/Re
DC Operating Life	Ta=25°C IF=1000mA	1000H	22	0/1
Reflow Soldering	Temp 210°C ± 5°C 5sec. min	1Time	22	0/1
Thermal Shock	-40°C/30min +100°C/30min	50Cycles	22	0/1
High Temperature Storage	100°C	168H	22	0/1
High Temperature High Humidity	85°C/85%RH	168H	22	0/1
Low Temperature Storage	-40°C	168H	22	0/1
ESD(HBM)	2000V HBN	1Time	10	0/1

Criteria For Judging the Damage

Items	Symbol	Limit		Test Condition
		L. S. L	U. S. L	
Luminous Intensity	IV	L. S. L08	—	IF=400mA
Forward Voltage	VF	—	L. S. 1.1	IF=400mA
Reverse Current	IR	—	L. S. 2.0	VR=5V

Note:

L. S. L: Lower Standard Level

L. S. L: Upper Standard Level

Soldering Condition

Reflow-Soldering			Manual Welding
	Beadsolder	Lead-free solder	Temperature
Preheat	120-150°C	180-200°C	Soldering time
Heatup time	120Sec Max	120Sec Max	
Peak temperature	240°C Max	260°C Max	highest 260°C 3seconds
Condition of Soldering time	10Secs Max	10Secs Max	Disposable devices

Packing Dimension

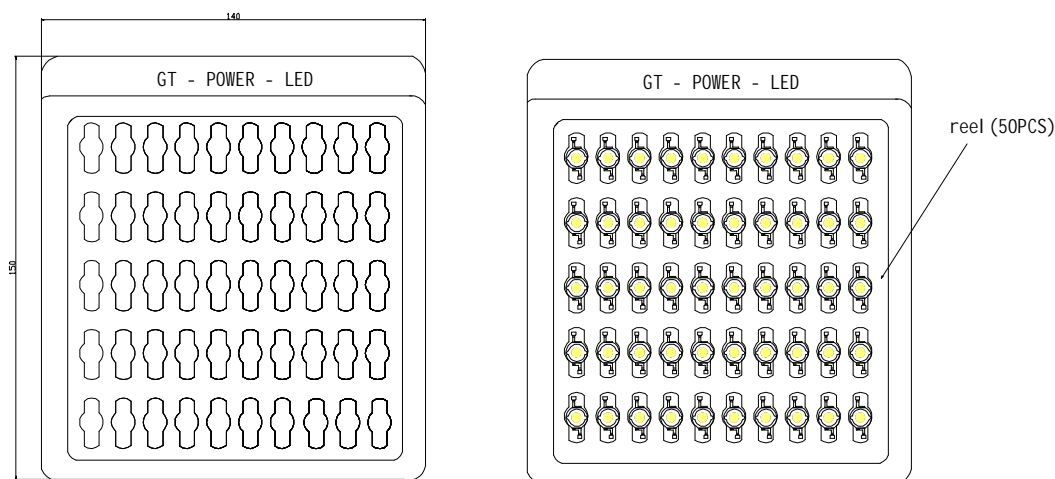

inner pack

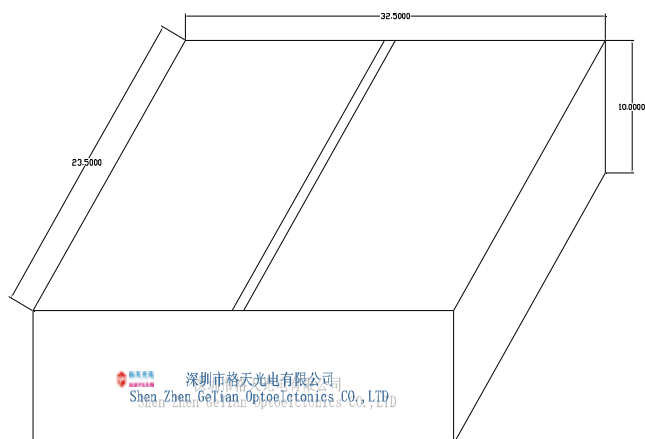

Outer pack