



深圳市格天光电有限公司

Shenzhen Getian Opto-Electronics Co., Ltd

# 产品规格书

The product specification

CUSTOMER/客户名称: \_\_\_\_\_

MODEL NO./产品型号: \_\_\_\_\_ GT-P04B3410110

DESCRIPTION/产品描述: \_\_\_\_\_ 1W蓝光

SAMPLE DATE/送样日期: \_\_\_\_\_

CUSTOMER AUTHORIZED SIGNATURE/客户承认签核

Please return to us a copy of "APPROVAL SHEET" after customer  
Signature./客户签字确认, 盖章后请回传一份承认书至我司。

engineering department 工程部		
APPROVED (核准)	CHECKED (审核)	DRAW UP (制定)

ADD: Building 55, East of Baotian Third Road, Xixiang, Baoan District,  
Shenzhen City, Guangdong Province, China 518102

地址: 深圳市宝安区西乡镇宝田三路东55栋

Tel/电话: 86-755-29656850

Fax/传真: 86-755-29656880

Http: //www.gt-led.com

E-mail: [getian@led.com](mailto:getian@led.com)

# GT-POWER LED Series

## Technical Datasheet for GT-03/04

GETIAN SEMICONDUCTOR

只做大功率

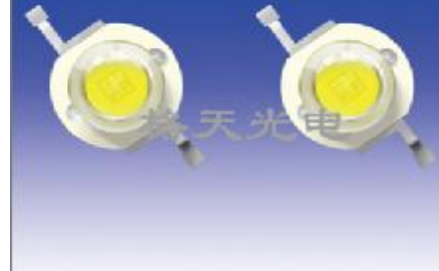

GT-Power series is designed for high current operation and high flux output applications. GT-Power LED its thermal management perform exceeds then other power LED solutions.

It integrate of the art SMD design and thermal emission material.

GT-Power LED is ideal light sources for general applications, custom designed solutions, and automotive large LCD backlights.

### Features

- \*Super high Flux output and high Luminance
- \*Designed for high current operation
- \*Low thermal resistance
- \*SMT solder bility
- \*Lead Free product
- \*ROHS compliant

### Applications

- \*General Illumination
  - Outdoor & Indoor architectural lighting
  - Decorative lighting
  - Torch lighting
  - Portable lighting and Reading lighting
  - Traffic signaling

## Full Code of GT-Power LED Series

Full code form:	<u>GT</u>	-	<u>P</u>	<u>XX</u>	<u>XX</u>	<u>X</u>	<u>X</u>	<u>X</u>	<u>X</u>	<u>XX</u>
	1		2	3	4	5	6	7	8	9
	GT		P	04	B3	4	1	0	1	10

### Part Number

1- GT: GeTi an

2- P : High Power LED

3- XX: Part sort

03: With baseplate      04: Without baseplate

4- XX: Emitted Color

R1 - Red 625nm      B3 - Blue 465nm      G6 - Green 515-525K

5- X : Wafer Size

2 - 24mil      3 - 30mil      4 - 45mil      5-50mil      6 - 60mil

6- X : Wafer Quantity

1 - 1EA      4 - 4EA

7- X : Viewing Angle

0 - 120deg      1 - 15deg

8- X : Power

0 - 0.5W      1 - 1W      3 - 3W

9- XX: Brightness Grade

60 - 60-80lm      10 - 15-30lm

## Outline Dimensions

### 1、 Dome Type

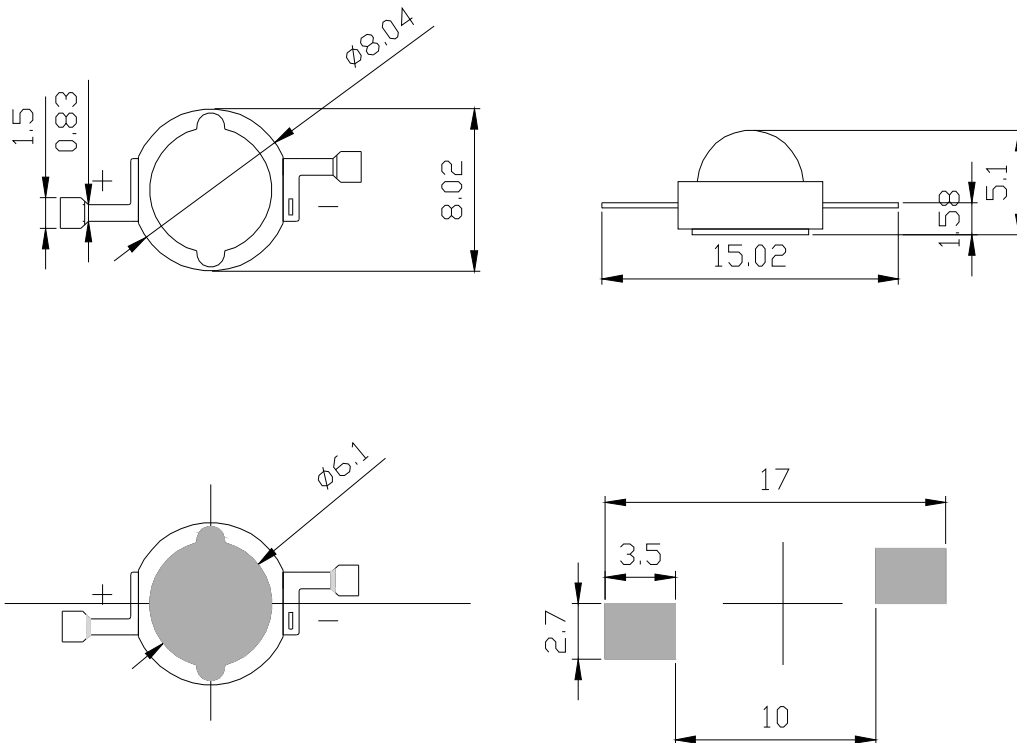

### 2、 Circuit diagram

[INTERNAL CIRCUIT DIAGRAM]

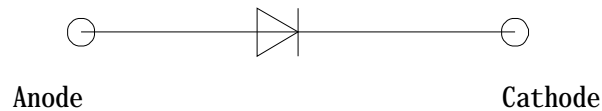

Notes

1. All dimensions are in millimeters.(tolerance:±0.2)
2. Scale:none

\*the appearance and specifications of the product may be changed for improvment without notice.

**Characteristics for GT-P04B3410110**
**1、 Neutral -White**

1-1 Electrical-Optical Characteristics at IF=350mA, TA=25°C

Parameter	Symbol	Value			Unit
		Min	Typ	Max	
Luminous Flux <sup>[1]</sup>	$\phi_v$ <sup>[2]</sup>	15	~	30	lm
Wavelength <sup>[3]</sup>	~	620	~	630	nm
Forward Voltage <sup>[4]</sup>	V <sub>F</sub>	3.0	~	3.6	V
View Angle	2θ1/2	120			deg.
Thermal Resistance <sup>[5]</sup>	R <sub>θ J-B</sub>	8			°C/W
Thermal Resistance <sup>[6]</sup>	R <sub>θ J-C</sub>	6.5			°C/W

1-2 Absolute Maximum Ratings

Parameter	Symbol	Value	Unit
Forward Current	I <sub>F</sub>	350	mA
Power Dissipation	P <sub>D</sub>	1	W
Junction Temperature	T <sub>j</sub>	120	°C
Operating Temperature	T <sub>opr</sub>	-30~+85	°C
Storage Temperature	T <sub>stg</sub>	-40~+120	°C
ESD Sensitivity <sup>[7]</sup>	~	±2,000V HBM	~

\*Notes:

[1] SSC maintains a tolerance of ±10% on flux and power measurements.

 [2]  $\phi_v$  is the total luminous flux output as measured with an integrated sphere.

[3] Correlated Color Temperatures is derived from the CIE 1931 Chromaticity diagram.

CCT ±5% testing tolerance

[4] A tolerance of ±0.06V on forward voltage measurements

 [5] ,[6] R<sub>θ J-B</sub> is measured with a SSC metal core pcb.(25°C ≤ T<sub>J</sub> ≤ 110°C)

 R<sub>θ J-C</sub> is measured with only emitter.. (25°C ≤ T<sub>J</sub> ≤ 110°C)

Break voltage of Metal PCB is 6.5kVAC

[7]It is included the zener chip to protect the product from ESD.

-----**Caution**-----

**Please do not drive at rated current more than 5sec. Without proper heat sink**

White Binning Information

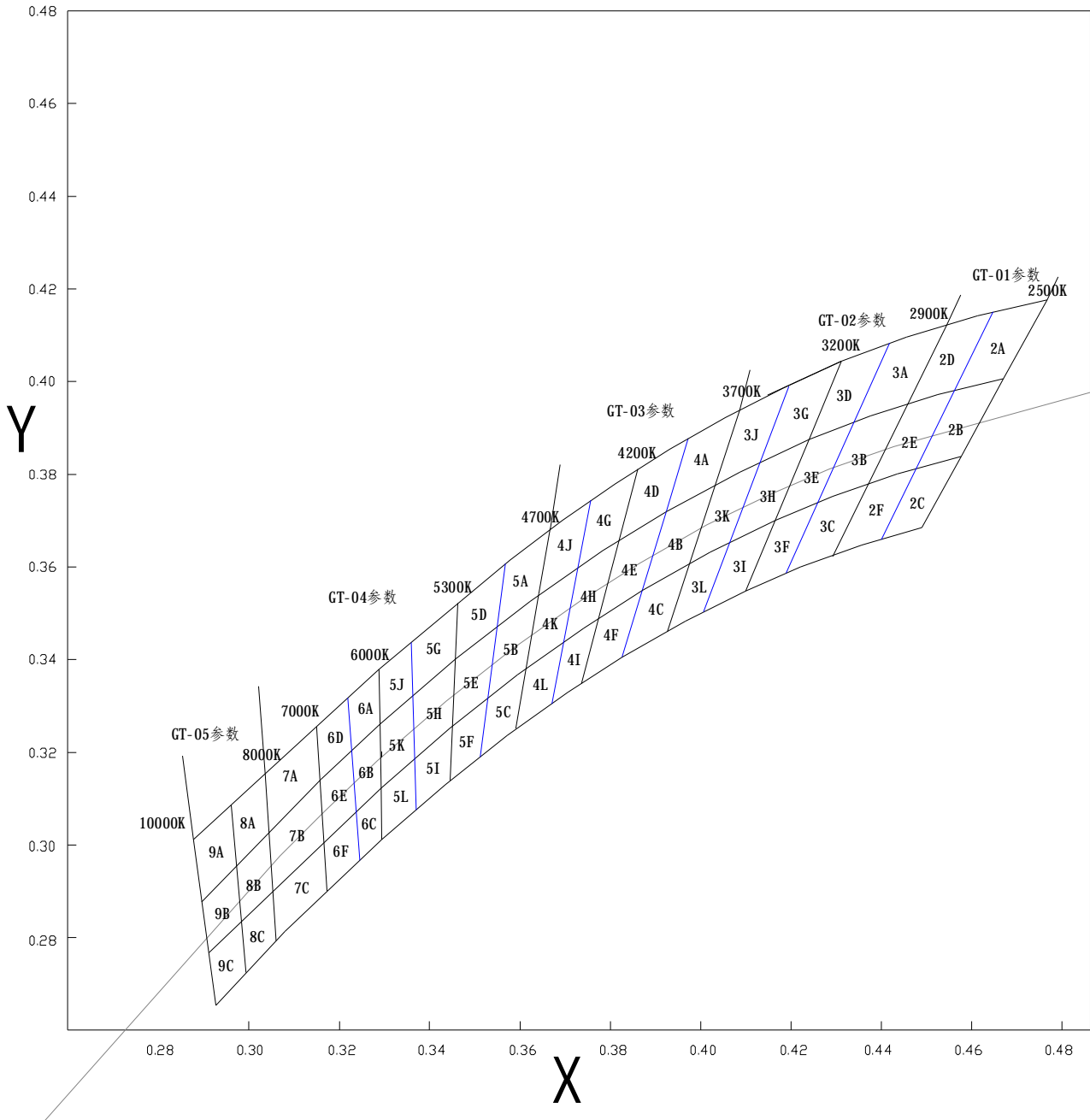

White Binning Sluze

<b>Division of BIN code and sample BIN code for white light</b>				
<b>BIN code</b>	<b>Color Temperature Range</b>		<b>Center Value</b>	<b>Sample BIN Code</b>
2A/2B/2C/2D/2E/2F	<b>2500-2900K</b>		<b>2700K</b>	<b>2E</b>
3A/3B/3C/3D/3E/3F	<b>2900-3200K</b>		<b>3000K</b>	<b>3B</b>
3G/3H/3I/3J/3K/3L	<b>3200-3700K</b>		<b>3500K</b>	<b>3H</b>
4A/4B/4C/4D/4E/4F	<b>3700-4200K</b>		<b>4000K</b>	<b>4E</b>
4G/4H/4I/4J/4K/4L	<b>4200-4700K</b>		<b>4500K</b>	<b>4H</b>
5A/5B/5C/5D/5E/5F	<b>4700-5300K</b>		<b>5000K</b>	<b>5B</b>
5G/5H/5I/5J/5K/5L	<b>5300-6000K</b>		<b>5700K</b>	<b>5K</b>
6A/6B/6C/6D/6E/6F	<b>6000-7000K</b>		<b>6500K</b>	<b>6B</b>
7A/7B/7C	<b>7000-8000K</b>		<b>7500K</b>	<b>7B</b>
8A/8B/8C/9A/9B/9C	<b>8000-10000K</b>		<b>9000K</b>	<b>8B</b>
<b>1.The division of luminous flux for white light is 10LM per grade</b>				
<b>2.The division of voltage for white light is 0.2V Per grade</b>				
<b>BIN Division Standard Of Red,Green,Blue</b>				
<b>Wavelength</b>	<b>Color</b>	<b>Lumen</b>	<b>Voltage(0.2V/each)</b>	<b>Total Amount of BIN</b>
<b>615-630 (2.5nm/each)</b>	<b>Red</b>	<b>10LM/each</b>	<b>2.0-2.6</b>	<b>36</b>
<b>515-530 (2.5nm/each)</b>	<b>Green</b>	<b>10LM/each</b>	<b>3.0-3.6</b>	<b>36</b>
<b>455-470 (2.5nm/each)</b>	<b>Blue</b>	<b>10LM/each</b>	<b>3.0-3.6</b>	<b>36</b>

## 1、Typical Radiatiation Patterns

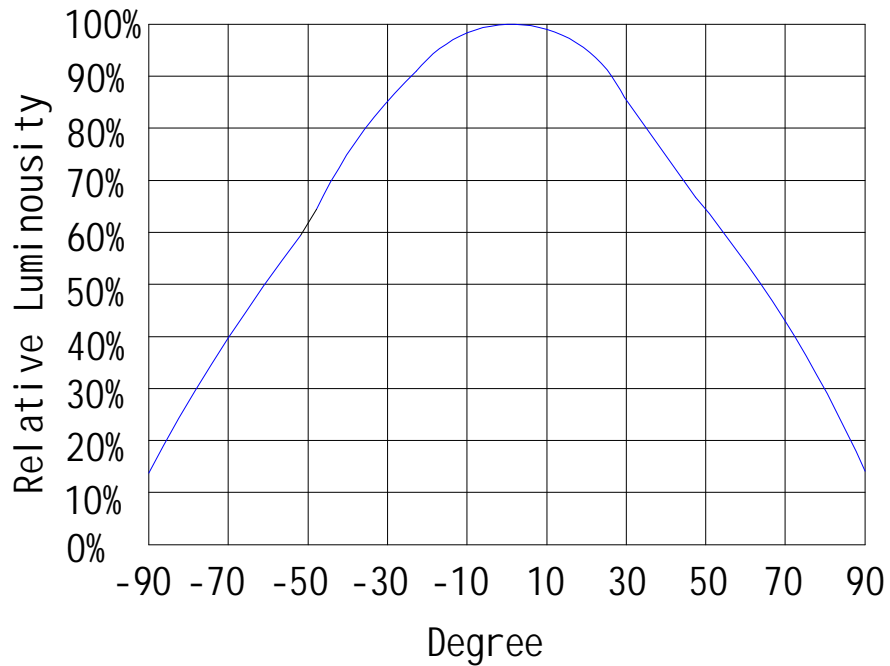

## 2、Typical representative Spatial Radiation Pattern

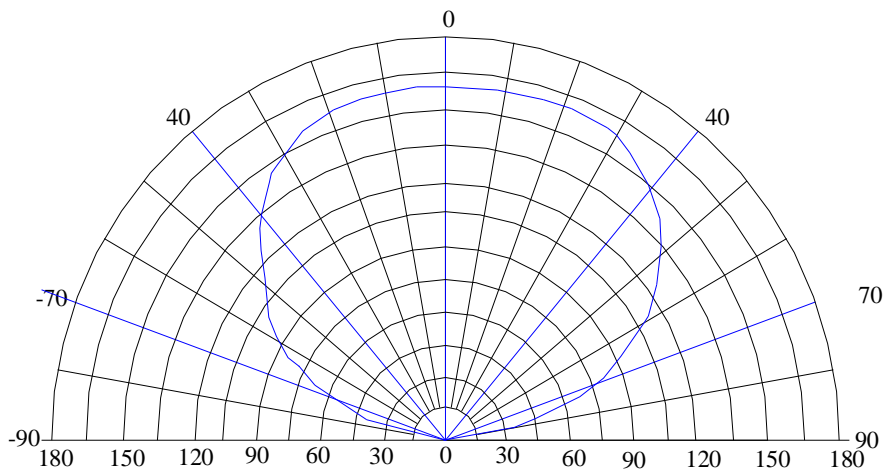

Typical Polar Radiation Pattern for White Lambertian



### 3、Neutral -White color spectrum of typical CCT part, integrated measurement

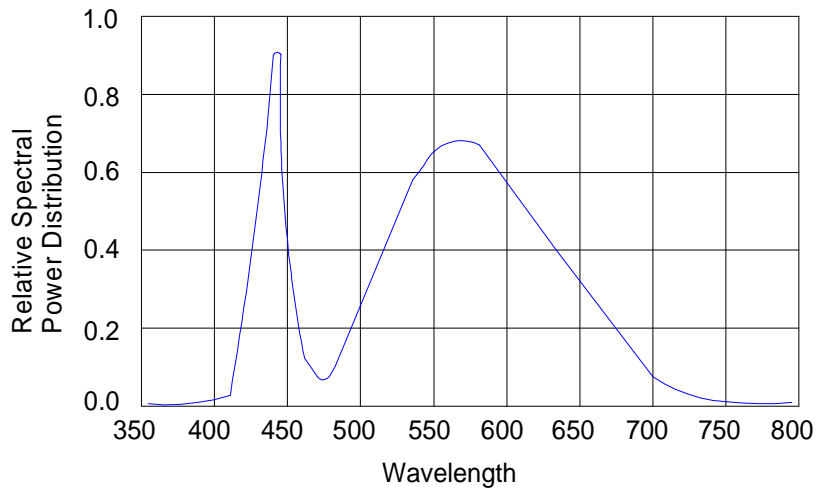

### 4、 Forward Current vs.Forward Voltage

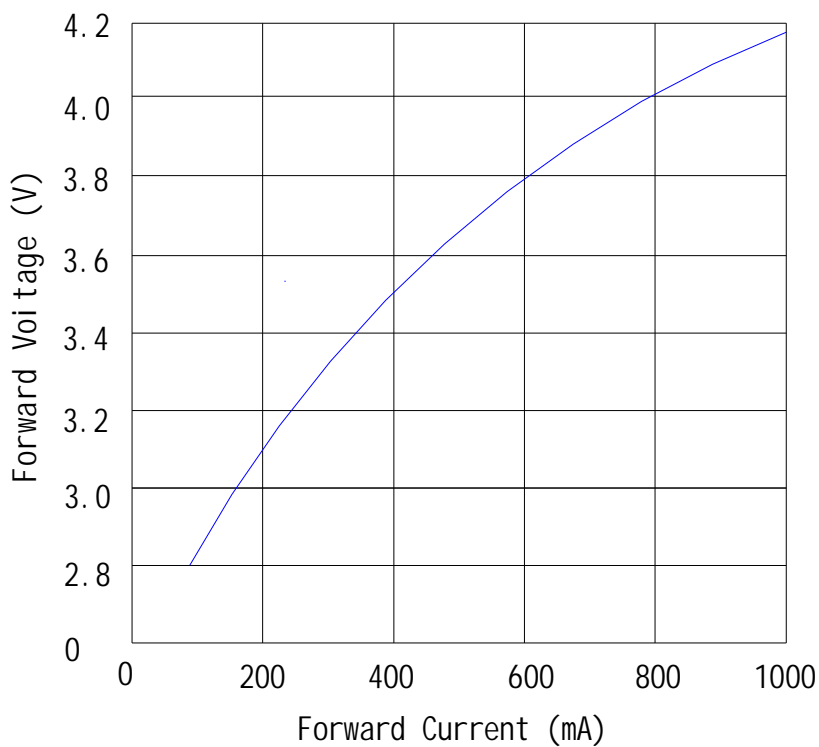

## 5、Relative Luminous Intensity vs. Ambient Temperature

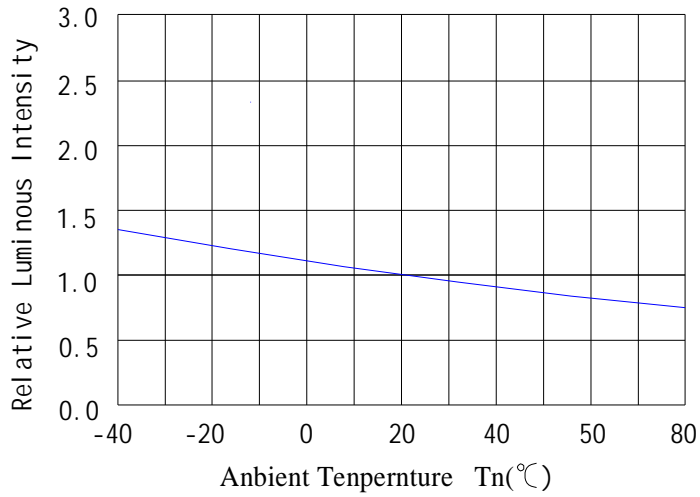

## 6、Forward Current Derting Curve, Derting based on $T_{i\max}=125^\circ\text{C}$

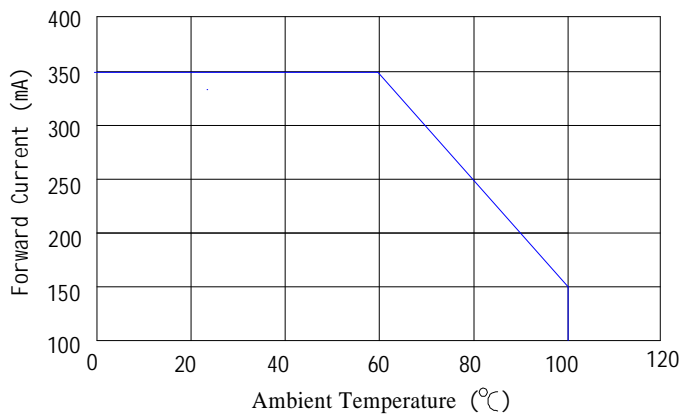

## 7、Relative Luminous Flux vs. Forward Current

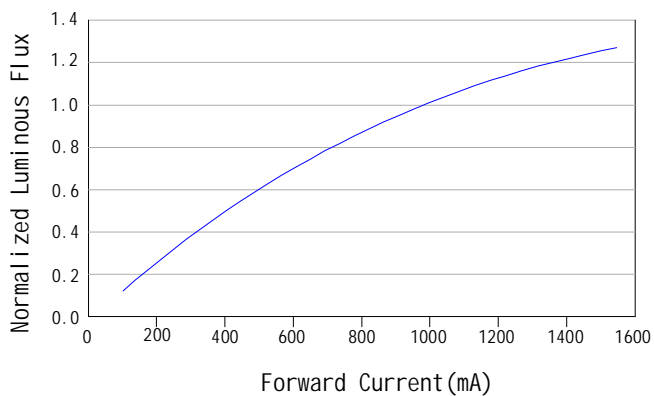

### Test Items And Condition

Items	Test Condition	Test Hours Cycles	Sample Size	Ac/Re
DC Operating Life	Ta=25°C IF=1000mA	1000H	22	0/1
Reflow Soldering	Temp 210°C ± 5°C 5sec. min	1Time	22	0/1
Thermal Shock	-40°C/30min +100°C/30min	50Cycles	22	0/1
High Temperature Storage	100°C	168H	22	0/1
High Temperature High Humidity	85°C/85%RH	168H	22	0/1
Low Temperature Storage	-40°C	168H	22	0/1
ESD(HBM)	2000V HBN	1Time	10	0/1

### Criteria For Judging the Damage

Items	Symbol	Limit		Test Condition
		L. S. L08	U. S. L	
Luminous Intensity	IV	—	—	IF=350mA
Forward Voltage	VF	—	L. S. 1.1	IF=350mA
Reverse Current	IR	—	L. S. 2.0	VR=5V

Note:

L. S. L: Lower Standard Level

U. S. L: Upper Standard Level

## Soldering Condition

Reflow-Soldering			Manual Welding
	Beadsolder	Lead-free solder	Temperature
Preheat	120-150°C	180-200°C	Soldering time
Heatup time	120Sec Max	120Sec Max	
Peak temperature	240°C Max	260°C Max	highest 260°C 3seconds
Condition of Soldering time	10Secs Max	10Secs Max	Disposable devices

## Packing Dimension

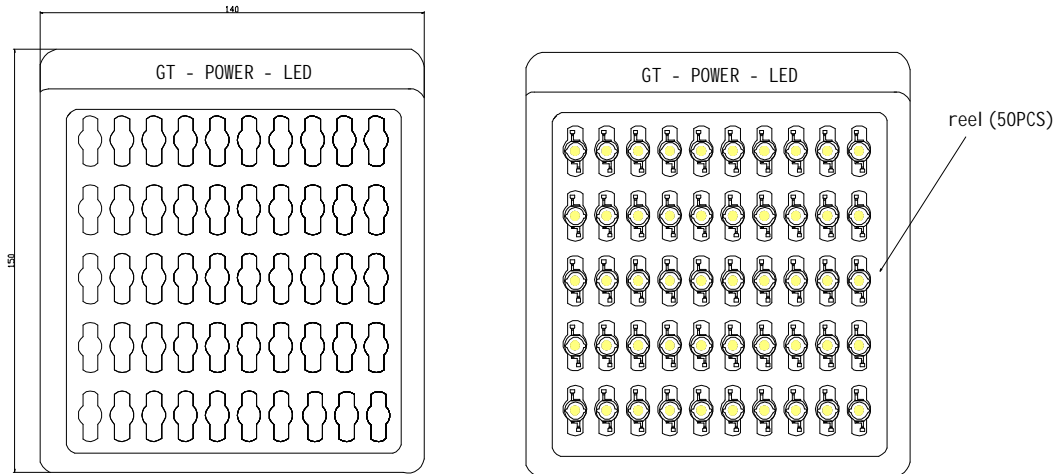

inner pack

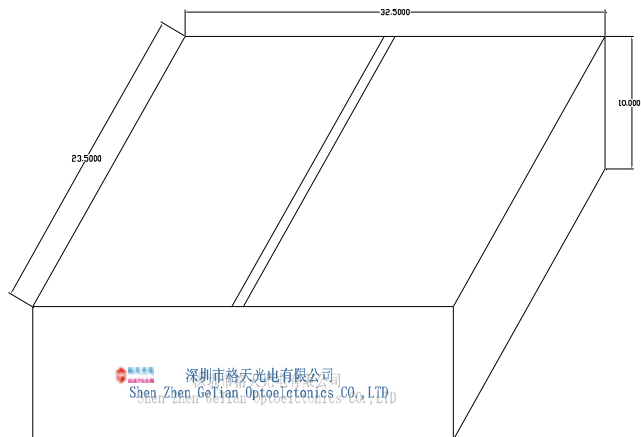

Outer pack